

P15

Werkstattwagen

mit 180 Werkzeugen für 4 Schubladen

815.4180

DER STARKE KOMPAKTE

P15



Werkstattwagen P15
mit 8 Schubladen
873.1008

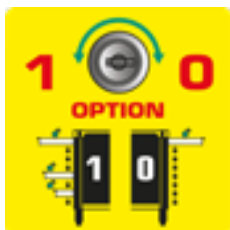

DUO Lock geniale Verschlusstechnik



8 Schubladen jeweils bis zu 50 kg belastbar



Stabiles **Kugellager**



Kunststoff-
oberfläche



Schloss
abschließbar

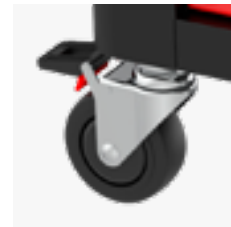

Antistatische Rollen
mit Bremse



Integrierter **Kantenschutz**



Inklusive **Papierrollenhalter**



Inklusive **Dosenhalter**

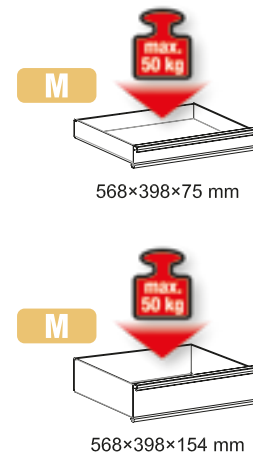
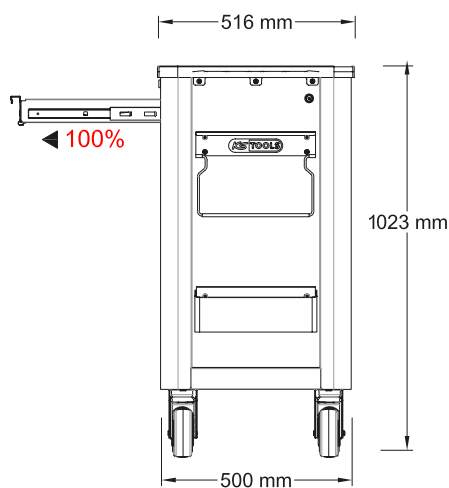
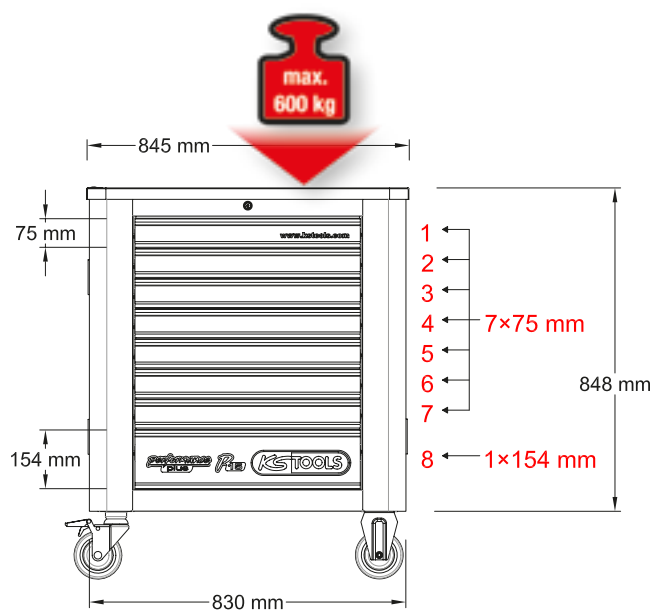

P15 Werkstattwagen

mit 180 Werkzeugen für 4 Schubladen

815.4180

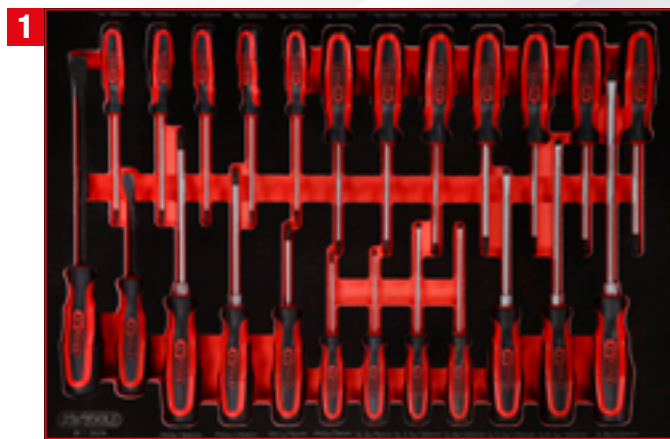

Schraubendreher-Satz

811.0024

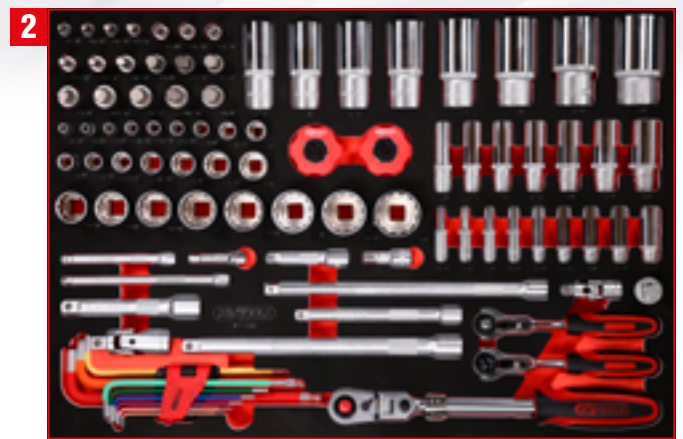

1/4" + 3/8" + 1/2" Steck-
schlüssel-Satz

811.0092

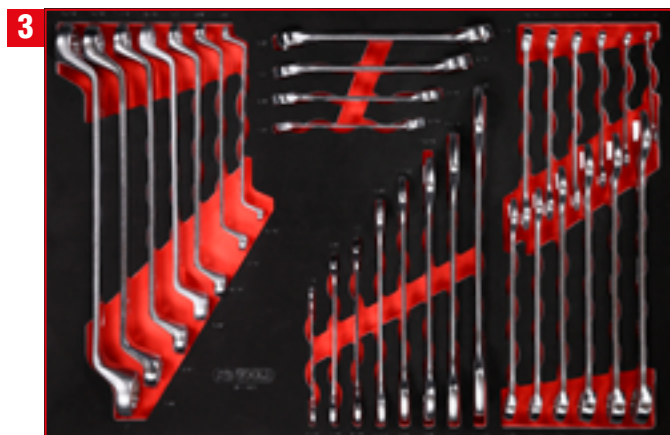

Schraubenschlüssel-Satz

811.0031



Zangen- / Hammer- / und
Meißel-Satz

811.0033



811.0024

M Schraubendreher-Satz

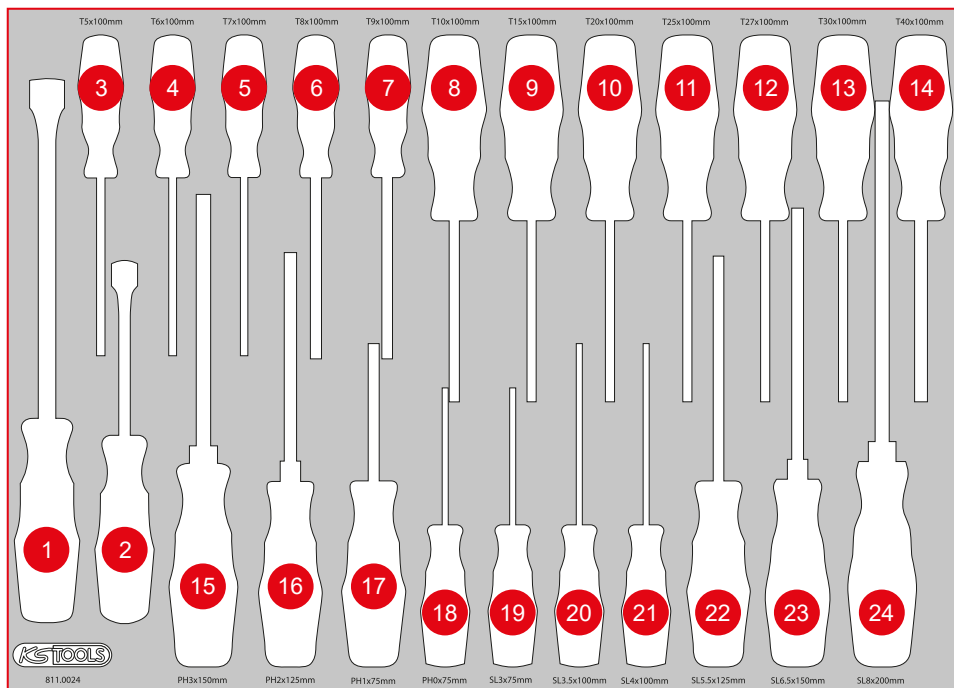
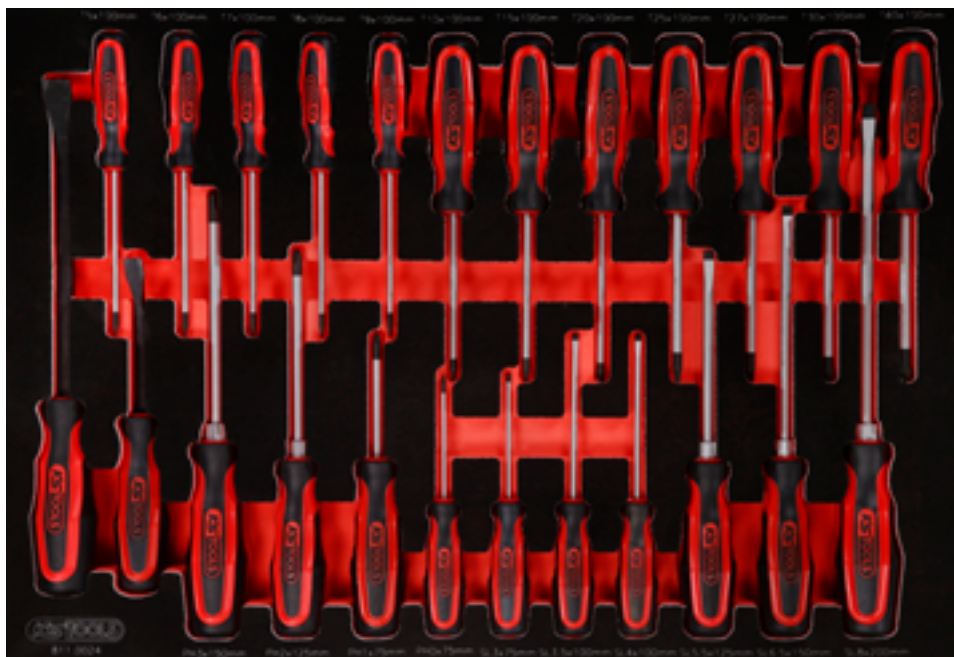

Pos.	Code	Bezeichnung	Teilligkeit
1	911.8102	Hebeleisen, 15 x 185 mm	1
2	911.8101	Hebeleisen, 11 x 115 mm	1
3	159.1133	ERGOTORQUEplus Schraubendreher, T5	1
4	159.1134	ERGOTORQUEplus Schraubendreher, T6	1
5	159.1135	ERGOTORQUEplus Schraubendreher, T7	1
6	159.1030	ERGOTORQUEplus Schraubendreher, T8	1
7	159.1031	ERGOTORQUEplus Schraubendreher, T9	1
8	159.1032	ERGOTORQUEplus Schraubendreher, T10	1
9	159.1033	ERGOTORQUEplus Schraubendreher, T15	1
10	159.1034	ERGOTORQUEplus Schraubendreher, T20	1
11	159.1035	ERGOTORQUEplus Schraubendreher, T25	1
12	159.1036	ERGOTORQUEplus Schraubendreher, T27	1
13	159.1037	ERGOTORQUEplus Schraubendreher, T30	1
14	159.1038	ERGOTORQUEplus Schraubendreher, T40	1
15	159.1024	ERGOTORQUEplus Schraubendreher, PH3, 265 mm	1
16	159.1022	ERGOTORQUEplus Schraubendreher, PH2, 230 mm	1
17	159.1020	ERGOTORQUEplus Schraubendreher, PH1, 180 mm	1
18	159.1027	ERGOTORQUEplus Schraubendreher, PH0, 155 mm	1
19	159.1002	ERGOTORQUEplus Schlitz-Schraubendreher, 3 mm, 155 mm lang	1
20	159.1112	ERGOTORQUEplus Schlitz-Schraubendreher, 3,5 mm, 180 mm lang	1
21	159.1004	ERGOTORQUEplus Schlitz-Schraubendreher, 4 mm, 180 mm lang	1
22	159.1006	ERGOTORQUEplus Schlitz-Schraubendreher, 5,5 mm, 230 mm lang	1
23	159.1009	ERGOTORQUEplus Schlitz-Schraubendreher, 6,5 mm, 255 mm lang	1
24	159.1011	ERGOTORQUEplus Schlitz-Schraubendreher, 8 mm, 315 mm lang	1

M 1/4" + 3/8" + 1/2" Steckschlüssel-Satz



TLG
92

568 x 398



Pos.	Code	Bezeichnung	Teiligkeit	Pos.	Code	Bezeichnung	Teiligkeit	Pos.	Code	Bezeichnung	Teiligkeit
1	914.1220	1/2" SlimPOWER Teleskop-Gelenk-Umschaltknarre, 72 Zahn	1	11	911.3802	3/8" Verlängerung mit Rändelung, 150 mm	1	26	917.3851	3/8" 12-kant-Stecknuss, 3/8"	1
2	914.3815	3/8" MODIFI x Mini-T-Griff-Schwenkkopf-Knarre, 72 Zahn, 0° +90°	1	12	911.3803	3/8" Verlängerung mit Rändelung, 250 mm	1	27	917.3852	3/8" 12-kant-Stecknuss, 7/16"	1
3	914.1405	1/4" MODIFI x Mini-T-Griff-Schwenkkopf-Knarre, 72 Zahn	1	13	911.1202	1/2" Verlängerung, 125 mm	1	28	911.4000	3/8" 12-kant-Stecknuss, 1/2"	1
4	151.4520	Kugelpfopf-Innensechskant-Winkelstiftschlüssel-Satz, extra lang, 9-tlg, Zoll	9	14	911.1203	1/2" Verlängerung, 250 mm	1	29	911.4001	3/8" 12-kant-Stecknuss, 9/16"	1
5	911.1250	1/2" Kardangelenke	1	15	911.3850	3/8" Kardangelenke	1	30	911.4003	3/8" 12-kant-Stecknuss, 5/8"	1
6	911.1423	1/4" Verlängerung mit Antriebssechskant, 50 mm	1	16	911.3826	3/8" Gleitstück/Reduzieradapter, 1/2" F x 3/8" M	1	31	911.4004	3/8" 12-kant-Stecknuss, 11/16"	1
7	911.1424	1/4" Verlängerung mit Antriebssechskant, 100 mm	1	17	917.1474	1/4" 12-kant-Stecknuss, 3/16"	1	32	911.4005	3/8" 12-kant-Stecknuss, 3/4"	1
8	911.1451	1/4" Verlängerung mit Antriebssechskant, 150 mm	1	18	917.1475	1/4" 12-kant-Stecknuss, 7/32"	1	33	917.1380	1/2" 12-kant-Stecknuss, 13/16"	1
9	911.3852	3/8" Verlängerung mit Rändelung, 45 mm	1	19	917.1476	1/4" 12-kant-Stecknuss, 1/4"	1	34	917.1381	1/2" 12-kant-Stecknuss, 7/8"	1
10	911.3801	3/8" Verlängerung mit Rändelung, 75 mm	1	20	917.1477	1/4" 12-kant-Stecknuss, 9/32"	1	35	917.1382	1/2" 12-kant-Stecknuss, 15/16"	1
				21	917.1478	1/4" 12-kant-Stecknuss, 5/16"	1	36	917.1383	1/2" 12-kant-Stecknuss, 1"	1
				22	917.1479	1/4" 12-kant-Stecknuss, 11/32"	1	37	917.1384	1/2" 12-kant-Stecknuss, 1.1/16"	1
				23	917.1480	1/4" 12-kant-Stecknuss, 3/8"	1	38	917.1385	1/2" 12-kant-Stecknuss, 1.1/8"	1
				24	917.1481	1/4" 12-kant-Stecknuss, 7/16"	1	39	917.1386	1/2" 12-kant-Stecknuss, 1.3/16"	1
				25	917.1482	1/4" 12-kant-Stecknuss, 1/2"	1	40	917.1387	1/2" 12-kant-Stecknuss, 1.1/4"	1

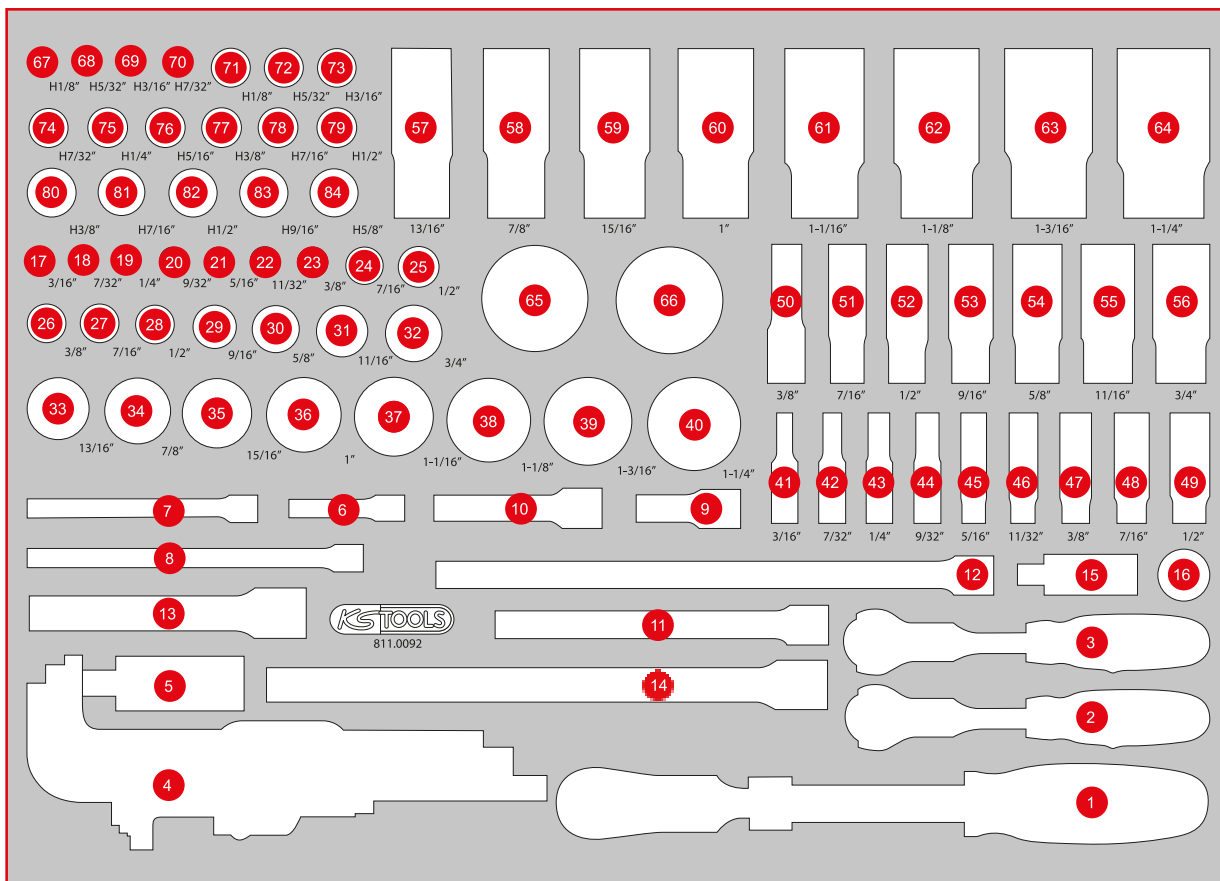

Pos.	Code	Bezeichnung	Teilligkeit	Pos.	Code	Bezeichnung	Teilligkeit	Pos.	Code	Bezeichnung	Teilligkeit
41	917.1565	1/4" 12-Kant-Stecknuss lang 3/16"	1	56	917.3989	3/8" 12-kant-Stecknuss, lang, 3/4"	1	71	917.3967	3/8" Bit-Stecknuss Innensechskant, 1/8"	1
42	917.1566	1/4" 12-Kant-Stecknuss lang 7/32"	1	57	917.1282	1/2" 12-kant-Stecknuss, lang, 13/16"	1	72	917.3962	3/8" Bit-Stecknuss Innensechskant, 5/32"	1
43	917.1567	1/4" 12-Kant-Stecknuss lang 1/4"	1	58	917.1283	1/2" 12-kant-Stecknuss, lang, 7/8"	1	73	917.3963	3/8" Bit-Stecknuss Innensechskant, 3/16"	1
44	917.1568	1/4" 12-Kant-Stecknuss lang 9/32"	1	59	917.1284	1/2" 12-kant-Stecknuss, lang, 15/16"	1	74	917.3968	3/8" Bit-Stecknuss Innensechskant, 7/32"	1
45	917.1569	1/4" 12-Kant-Stecknuss lang 5/16"	1	60	917.1289	1/2" 12-kant-Stecknuss, lang, 1"	1	75	917.3964	3/8" Bit-Stecknuss Innensechskant, 1/4"	1
46	917.1570	1/4" 12-Kant-Stecknuss lang 11/32"	1	61	917.5348	1/2" 12-kant-Stecknuss, lang, 1.1/16"	1	76	917.3965	3/8" Bit-Stecknuss Innensechskant, 5/16"	1
47	917.1571	1/4" 12-Kant-Stecknuss lang 3/8"	1	62	917.5349	1/2" 12-kant-Stecknuss, lang, 1.1/8"	1	77	917.3966	3/8" Bit-Stecknuss Innensechskant, 3/8"	1
48	917.1572	1/4" 12-Kant-Stecknuss lang 7/16"	1	63	917.5353	1/2" 12-kant-Stecknuss, lang, 1.3/16"	1	78	917.3993	3/8" Bit-Stecknuss Innensechskant, 7/16"	1
49	917.1573	1/4" 12-Kant-Stecknuss lang 1/2"	1	64	917.5351	1/2" 12-kant-Stecknuss, lang, 1.1/4"	1	79	917.3994	3/8" Bit-Stecknuss Innensechskant, 1/2"	1
50	917.3983	3/8" 12-kant-Stecknuss, lang, 3/8"	1	65	914.3810	3/8" Mini-Hand-Umschaltknarre, 72 Zahn	1	80	917.1321	1/2" Bit-Stecknuss Innensechskant, kurz, 3/8"	1
51	917.3984	3/8" 12-kant-Stecknuss, lang, 7/16"	1	66	914.1410	1/4" Mini-Hand-Umschaltknarre, 72 Zahn	1	81	911.5387	1/2" Bit-Stecknuss Innensechskant, kurz, 7/16"	1
52	917.3985	3/8" 12-kant-Stecknuss, lang, 1/2"	1	67	917.1440	1/4" Bit-Stecknuss Innensechskant, 1/8"	1	82	917.1322	1/2" Bit-Stecknuss Innensechskant, kurz, 1/2"	1
53	917.3986	3/8" 12-kant-Stecknuss, lang, 9/16"	1	68	917.1441	1/4" Bit-Stecknuss Innensechskant, 5/32"	1	83	917.1323	1/2" Bit-Stecknuss Innensechskant, kurz, 9/16"	1
54	917.3987	3/8" 12-kant-Stecknuss, lang, 5/8"	1	69	917.1442	1/4" Bit-Stecknuss Innensechskant, 3/16"	1	84	917.1324	1/2" Bit-Stecknuss Innensechskant, kurz, 5/8"	1
55	917.3988	3/8" 12-kant-Stecknuss, lang, 11/16"	1	70	917.1443	1/4" Bit-Stecknuss Innensechskant, 7/32"	1				

M Schraubenschlüssel-Satz



Pos.	Code	Bezeichnung	Teiligkeit
1	517.0895	Doppel-Ringschlüssel, gekröpft, 15/16 x 1"	1
2	517.0894	Doppel-Ringschlüssel, gekröpft, 13/16 x 7/8"	1
3	517.0889	Doppel-Ringschlüssel, gekröpft, 11/16 x 3/4"	1
4	517.0887	Doppel-Ringschlüssel, gekröpft, 9/16 x 5/8"	1
5	517.0885	Doppel-Ringschlüssel, gekröpft, 1/2 x 9/16"	1
6	517.0883	Doppel-Ringschlüssel, gekröpft, 3/8 x 7/16"	1
7	517.0881	Doppel-Ringschlüssel, gekröpft, 1/4 x 5/16"	1
8	517.9268	Offener Doppelringschlüssel, abgew. 5/8" x 11/16"	1
9	517.9267	Offener Doppelringschlüssel, abgew. 1/2" x 9/16"	1
10	517.9266	Offener Doppelringschlüssel, abgew. 3/8" x 7/16"	1
11	517.9265	Offener Doppelringschlüssel, abgew. 1/4" x 5/16"	1
12	517.0781	Doppel-Maulschlüssel, 1/4 x 5/16"	1
13	517.0783	Doppel-Maulschlüssel, 3/8 x 7/16"	1
14	517.0785	Doppel-Maulschlüssel, 1/2 x 9/16"	1
15	517.0788	Doppel-Maulschlüssel, 5/8 x 11/16"	1
16	517.0789	Doppel-Maulschlüssel, 11/16 x 3/4"	1
17	517.0794	Doppel-Maulschlüssel, 13/16 x 7/8"	1
18	517.0795	Doppel-Maulschlüssel, 15/16 x 1"	1
19	517.0774	Doppel-Maulschlüssel, 1.1/8" x 1.1/4"	1
20	517.1901	Ringmaulschlüssel, abgewinkelt, 1/4"	1
21	517.1902	Ringmaulschlüssel, abgewinkelt, 5/16"	1
22	517.1903	Ringmaulschlüssel, abgewinkelt, 3/8"	1
23	517.1904	Ringmaulschlüssel, abgewinkelt, 7/16"	1
24	517.1951	Ringmaulschlüssel, abgewinkelt, 1/2"	1
25	517.1906	Ringmaulschlüssel, abgewinkelt, 9/16"	1
26	517.1907	Ringmaulschlüssel, abgewinkelt, 5/8"	1
27	517.1908	Ringmaulschlüssel, abgewinkelt, 11/16"	1
28	517.1909	Ringmaulschlüssel, abgewinkelt, 3/4"	1
29	517.1912	Ringmaulschlüssel, abgewinkelt, 13/16"	1
30	517.1913	Ringmaulschlüssel, abgewinkelt, 7/8"	1
31	517.1914	Ringmaulschlüssel, abgewinkelt, 15/16"	1

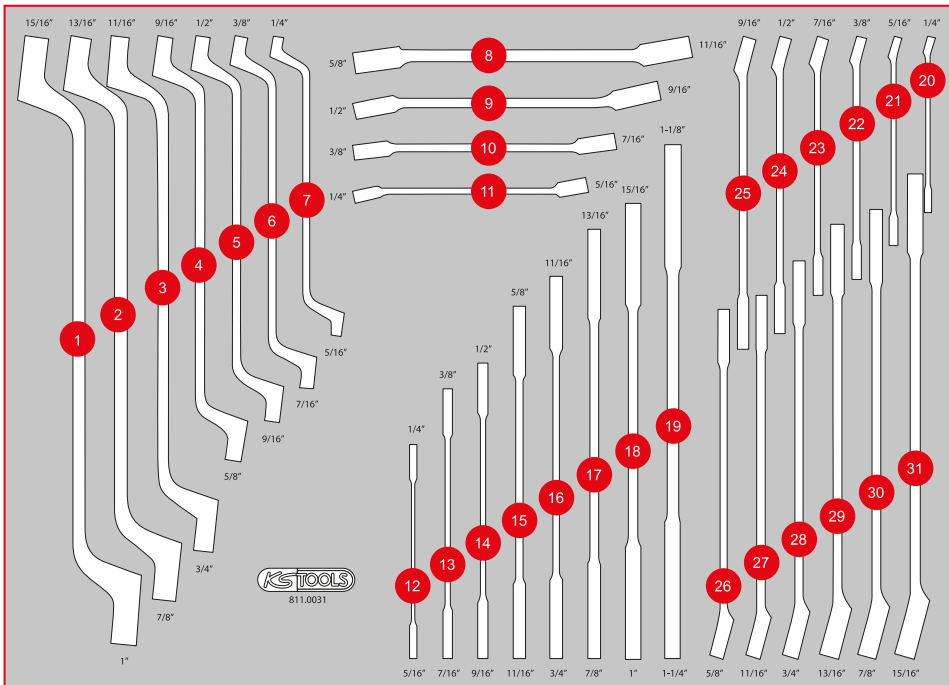

811.0033

M Zangen- / Hammer- / und Meißel-Satz

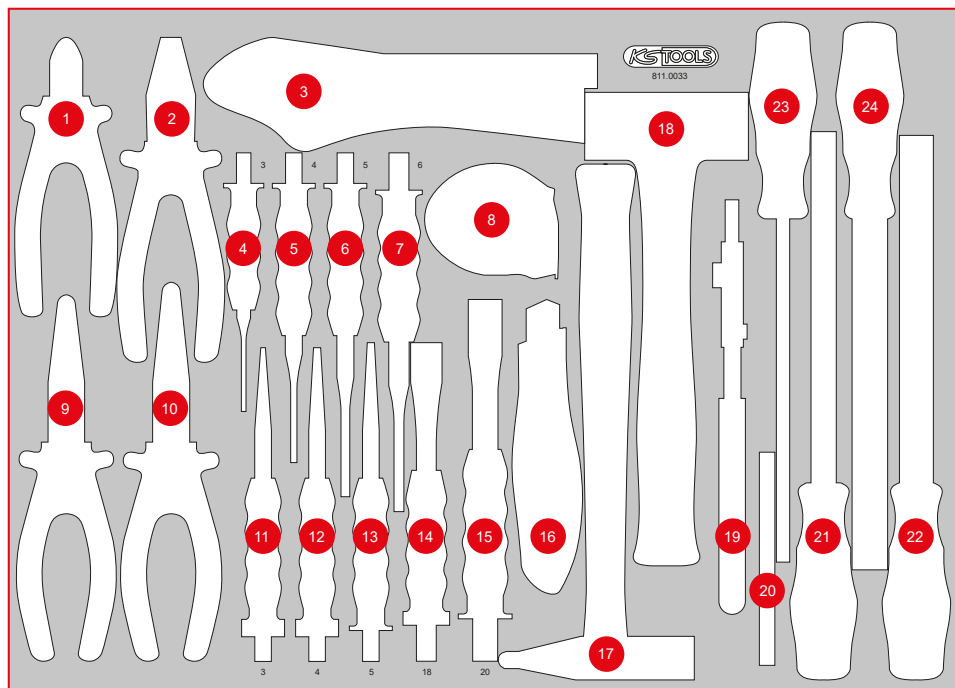

Pos.	Code	Bezeichnung	Teiligkeit
1	115.1012	ERGOTORQUE Diagonal-Seitenschneider, 160 mm	1
2	115.1021	ERGOTORQUE Kombinationszange, 180 mm	1
3	115.1033	Gripzange, 60 mm, 220 mm	1
4	156.0231	Durchtreiber, Ø 3 mm, zylindrisch	1
5	156.0232	Splintentreiber, Ø 4 mm, zylindrisch	1
6	156.0233	Durchtreiber, Ø 5 mm, zylindrisch	1
7	156.0234	Durchtreiber, Ø 6 mm, zylindrisch	1
8	300.0114	Bandmaß mit Feststeller, schwarz-rot, 5 m, 19 mm	1
9	115.1019	ERGOTORQUE Flachrundzange, gebogen, 210 mm	1
10	115.1024	ERGOTORQUE Telefonzange, 200 mm	1
11	156.0237	Durchtreiber mit Handschutzgriff, 8-kant, konisch, 3 mm	1
12	156.0238	Durchtreiber mit Handschutzgriff, 8-kant, konisch, 4 mm	1
13	156.0244	Durchtreiber, Ø 5 mm, konisch	1
14	156.0254	Flachmeißel mit Handschutzgriff, 8-kant, 18 mm	1
15	156.0241	Flachmeißel mit Handschutzgriff, 8-kant, 20 mm	1
16	907.2135	Universal-Abbrechklingen-Messer 18 mm	1
17	142.1402	Schlosser Hammer mit Fiberglasstiel, 400 g	1
18	142.5101	Fäustel mit Fiberglasstiel, 1000 g	1
19	115.2010	Wasserpumpenzange mit Druckknopfverstellung, 240 mm	1
20	907.2166	Abbrechklingen 0,5 x 18 x 100 mm, Spender à 10 Stück	10
21	157.0405	Dreikant-Feile, Form C, 200 mm, Hieb 2	1
22	157.0105	Halbrund-Feile, Form E, 200 mm, Hieb 2	1
23	157.0205	Rund-Feile, Form F, 200 mm, Hieb 2	1
24	157.0005	Flachfeile, Form B, 200 mm, Hieb 2	1

P15

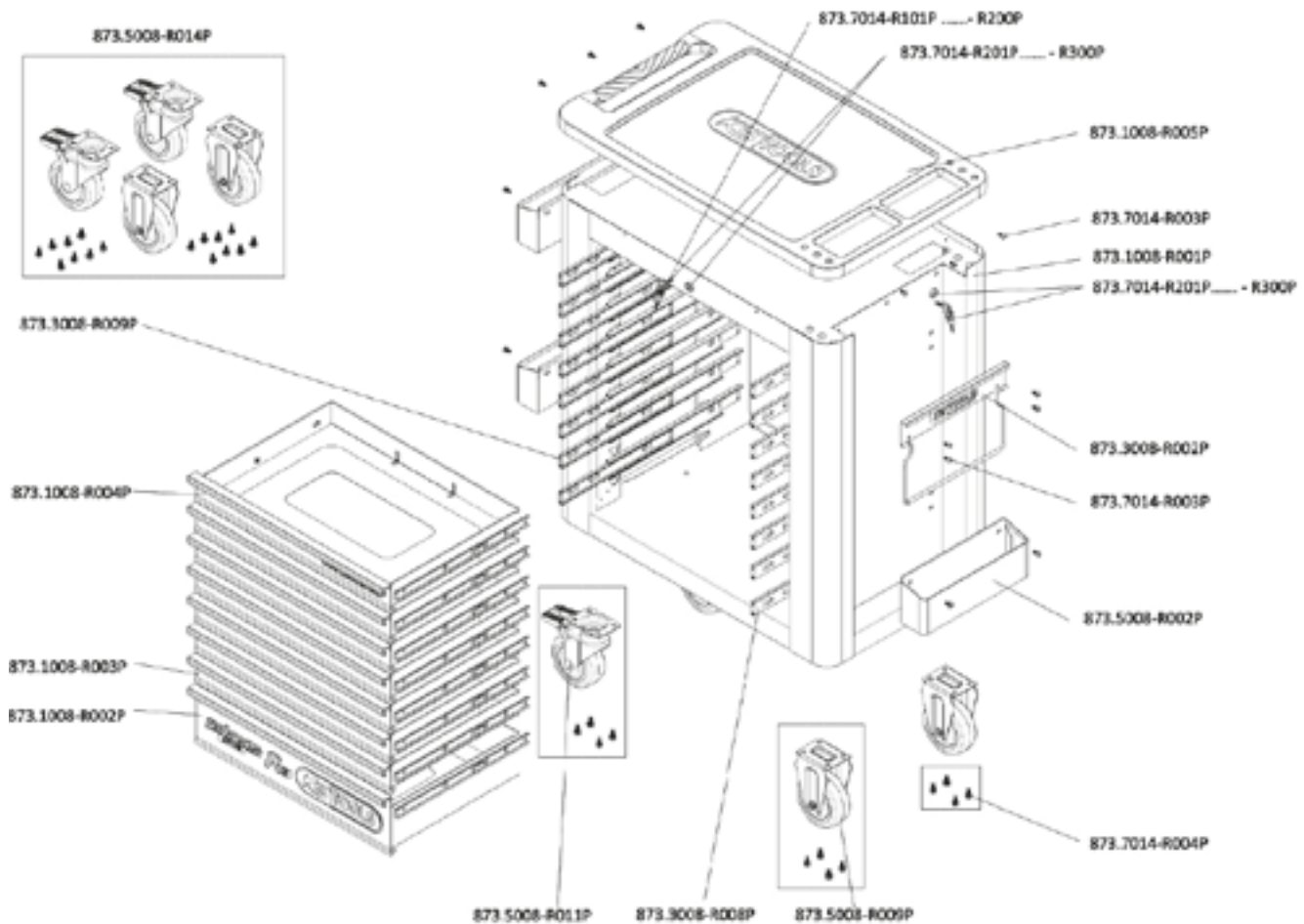

EINZELTEIL-LISTE

Art.-Nr.	Beschreibung	Menge
873.7014-R101P...	Ersatzschlüssel für Schloß Nummer xyz zu PERFORMANCEplus Werkstattwagen	2
873.7014-R201P...	Schloß mit 2 Schlüsseln zu PERFORMANCEplus Werkstattwagen Schloß-Nr. xyz	2
873.1008-R001P	Korpus zu Werkstattwagen P15	1
873.1008-R002P	Schublade mit Logo und Kugelführung zu Werkstattwagen P15, 568x398x145 mm	1
873.1008-R003P	Schublade mit Kugelführung zu Werkstattwagen P10/P10TC/P15, 568x398x65 mm	6
873.1008-R004P	Schublade mit Website und Kugelführung zu Werkstattwagen P10/P15, 568x398x65 mm	1
873.1008-R005P	Kunststoff Arbeitsplatte mit Handgriff zu Werkstattwagen P15	1
873.3008-R002P	Papierrollen-Halter zu PERFORMANCEplus Werkstattwagen P10/P15/P25	1
873.3008-R008P	Vollauszug Kugelführung mit autom. Rückzug	8
873.3008-R009P	Vollauszug Kugelführung mit autom. Rückzug	8
873.5008-R002P	Dosen-Halter zu PERFORMANCEplus Werkstattwagen P10/P15/P25/P35	3
873.5008-R009P	Laufrolle starr für PERFORMANCEplus Werkstattwagen inkl. Schrauben	2
873.5008-R011P	Lenkrolle mit Bremse zu PERFORMANCEplus Werkstattwagen inkl. Schrauben	2
873.5008-R014P	Rollen-Satz zu PERFORMANCEplus Werkstattwagen inkl. Schrauben	1
873.7014-R003P	Schraube M6x12 für PERFORMANCEplus Werkstattwagen-Zubehör	16
873.7014-R004P	Schraube M8 für Rollen zu PERFORMANCEplus Werkstattwagen (16 Stück)	1



873.7014-R101P...R200P
Ersatzschlüssel für Schlossnum-
mer xyz



873.7014-R201P...R300P
Schloss inklusive 2 Schlüssel,
Schlossnummer xyz



873.3008-R008P
Laufschiene mit Selbsteinzug,
für Schublade, rechts



873.3008-R009P
Laufschiene mit Selbsteinzug,
für Schublade, links



873.5008-R009P
Laufrolle, starr, inklusive
Schrauben



873.5008-R011P
Lenkrolle mit Feststellbremse
inklusive Schrauben



873.5008-R014P
Rollensatz, 2 x Lenkrolle + 2 x
Laufrolle, inklusive Schrauben



873.1008-R005P
Kunststoff-Arbeitsplatte mit Griff



873.1008-R004P
Schublade mit Website, inklusive
Laufschiene, H=65 mm, B=568
mm x T=398 mm



873.1008-R003P
Schublade, inklusive Laufschiene,
H=65 mm, B=568 mm x T=398 mm



873.1008-R002P
Schublade mit Logo, inklusive
Laufschiene, H=145 mm,
B=568 mm x T=398 mm



873.5008-R002P
Dosenhalter inklusive Schrauben,
B = 310 mm



873.3008-R002P
Papirollenhalter inklusive
Schrauben, B = 320 mm



873.7014-R004P
Schraube, M8, mit Unterlegschei-
be, 16 Stück



873.7014-R003P
Schraube, M6 x 12 mm, 1 Stück



873.1008-R001P
Stahlkorpus



Unersetzlich ist nur
die Qualität!