

HOHE SCHUBLADEN FÜR HÖCHSTE ANSPRÜCHE

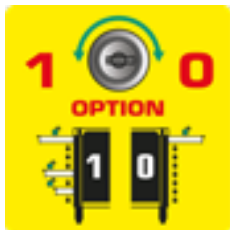

Werkstattwagen P40
mit 4 Schubladen
873.6008



DUO Lock geniale Verschlusstechnik



4 Schubladen jeweils bis zu 65 kg belastbar



Stabiles **Kugellager**



Edelstahloberfläche

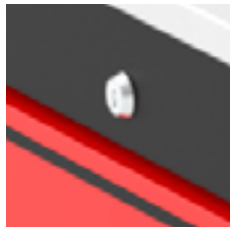

Schloss abschließbar



Antistatische Rollen mit Bremse



Integrierter **Kantenschutz**



Inklusive **Papierrollenhalter**



Inklusive **Dosenhalter**

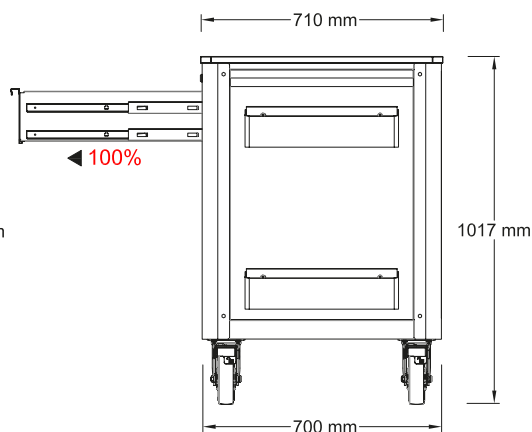
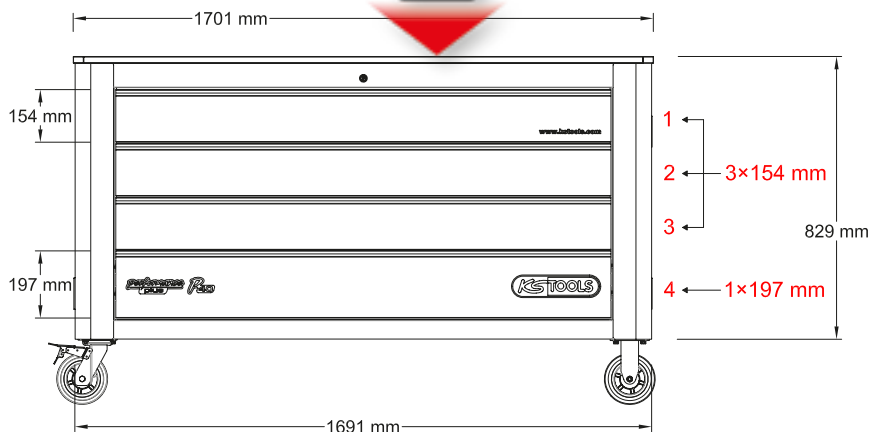
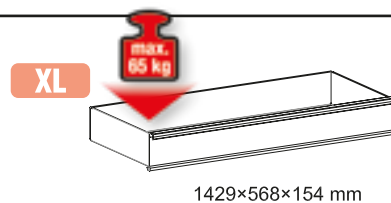
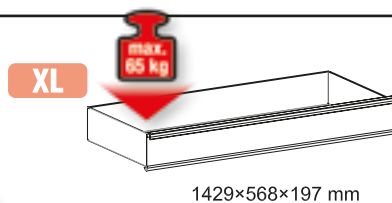

P40

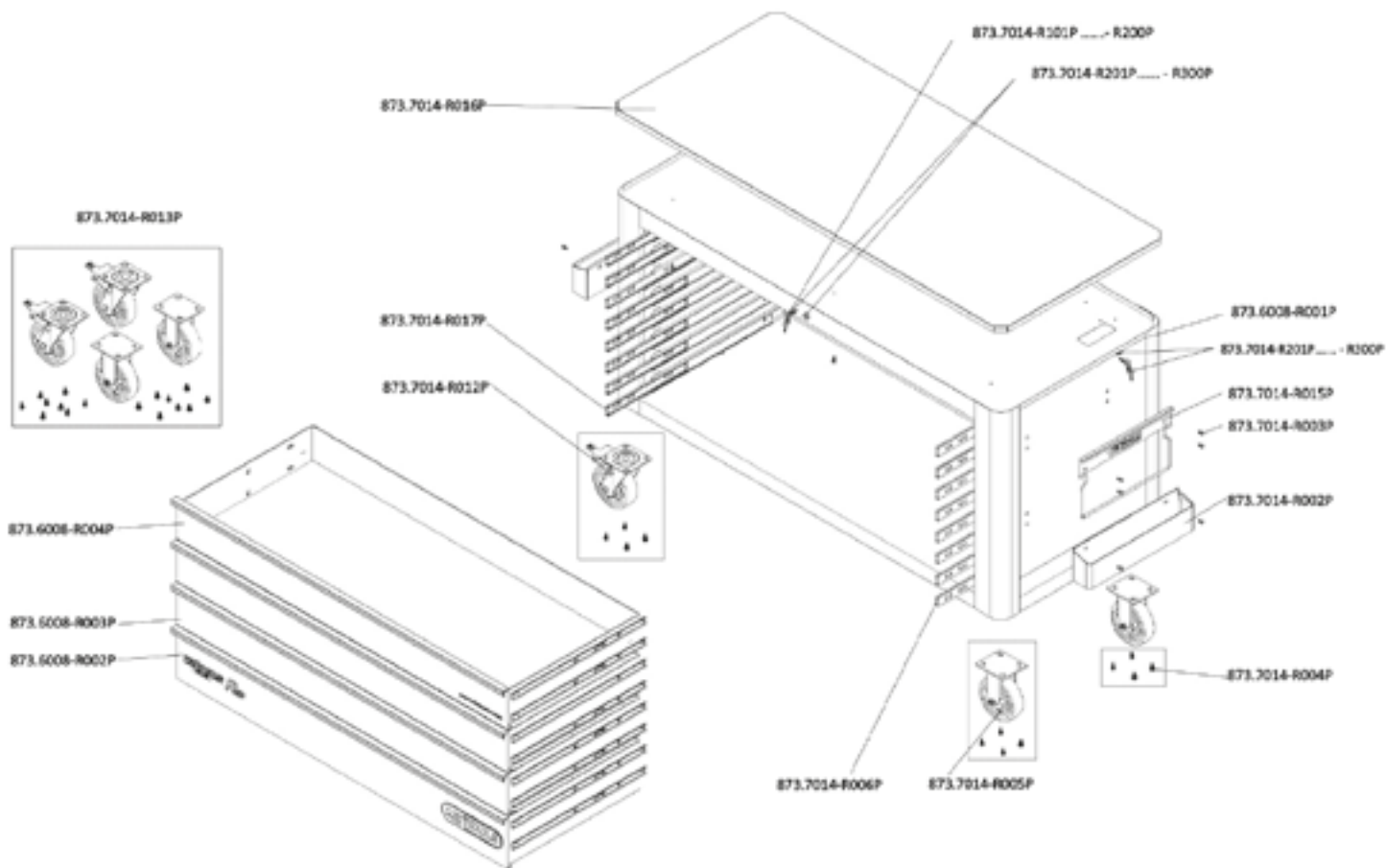

EINZELTEIL-LISTE

Art.-Nr.	Beschreibung	Menge
873.7014-R101P...	Ersatzschlüssel für Schloß Nummer xyz zu PERFORMANCEplus Werkstattwagen	2
873.7014-R201P...	Schloß mit 2 Schlüsseln zu PERFORMANCEplus Werkstattwagen Schloß-Nr. xyz	2
873.6008-R001P	Korpus mit Handgriff zu Werkstattwagen P40	1
873.6008-R002P	Schublade mit Logo und Kugelführung zu Werkstattwagen P40, 1429x568x180 mm	1
873.6008-R003P	Schublade mit Kugelführung zu Werkstattwagen P40, 1429x568x145 mm	2
873.6008-R004P	Schublade mit Website und Kugelführung zu Werkstattwagen P40, 1429x568x145 mm	1
873.7014-R002P	Dosen-Halter zu PERFORMANCEplus Werkstattwagen P20/P30/P35/P40/P45	3
873.7014-R003P	Schraube M6x12 für PERFORMANCEplus Werkstattwagen-Zubehör	10
873.7014-R004P	Schraube M8 für Rollen zu PERFORMANCEplus Werkstattwagen (16 Stück)	1
873.7014-R005P	Laufrolle starr inkl. Schrauben	2
873.7014-R006P	Vollauszug Kugelführung mit autom. Rückzug	8
873.7014-R012P	Lenkrolle inkl. Schrauben	2
873.7014-R013P	Rollen-Satz inkl. Schrauben	1
873.7014-R017P	Vollauszug Kugelführung mit autom. Rückzug	8
873.7014-R015P	Papierrollen-Halter zu PERFORMANCEplus Werkstattwagen P20/P30/P35/P40/P45	1
873.7014-R016P	Edelstahl Arbeitsplatte	1

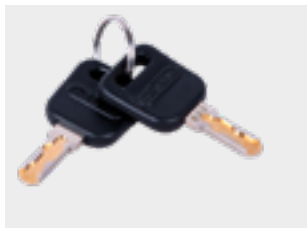

873.7014-R101P...R200P
Ersatzschlüssel für Schlossnummer xyz



873.7014-R201P...R300P
Schloss inklusive 2 Schlüssel, Schlossnummer xyz



873.7014-R006P
Laufschiene für Schublade mit Selbsteinzug, rechts



873.7014-R017P
Laufschiene für Schublade mit Selbsteinzug, links

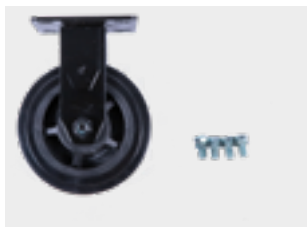

873.7014-R005P
Laufrolle, starr, inklusive Schrauben



873.7014-R012P
Lenkrolle mit Feststellbremse inklusive Schrauben



873.7014-R013P
Rollensatz, 2 x Lenkrolle + 2 x Laufrolle, inklusive Schrauben



873.7014-R016P
Edelstahl-Arbeitsplatte



873.6008-R004P
Schublade mit Webside, inklusive Laufschiene, H=145 mm, B=1429 mm x T=568 mm



873.6008-R003P
Schublade, inklusive Laufschiene, H=145 mm, B=1429 mm x T=568 mm



873.6008-R002P
Schublade mit Logo, inklusive Laufschiene, H=180 mm, B=1429 mm x T=568 mm



873.7014-R002P
Dosenhalter inklusive Schrauben, B = 445 mm



873.7014-R015P
Papierrollenhalter inklusive Schrauben, B = 400 mm

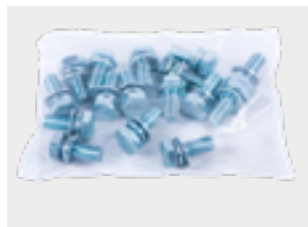

873.7014-R004P
Schraube, M8, mit Unterlegscheibe, 16 Stück



873.7014-R003P
Schraube, M6 x 12 mm, 1 Stück



873.6008-R001P
Stahlkorpus mit Griff



Immer wie neu dank
perfekter Teile!

JEDER WAGEN EIN UNIKAT

**Werkzeugaufnahmen, Rohrhalter, Ablageböden,
Magnetschalen, Klemmen, Halter und Haken:
Das umfangreiche Zubehörprogramm von
Performance Plus lässt keine Wünsche offen und
macht Ihren Werkstattwagen zu Ihrem persön-
lichen Unikat. Erweitern Sie Ihre Performance!**

**FREI KONFIGURIERBAR –
AUCH NACH DEM KAUF**

**Komplett auf Ihre Bedürfnisse
abgestimmt**

**AUFNAHMEN FÜR ALLE
WERKZEUGARTEN**

ZUBEHÖR

- passend für Lochmaß 10 x 10 mm – Lochabstand 38 mm
- inklusive Fixierschraube
- Grundplattenstärke 1,5 mm
- verzinkt
- Stahlblech



860.0855
Rohrhalter, Ø 60 mm
paarweise zu benutzen



860.0856
Rohrhalter, Ø 100 mm



860.0857
Ablageboden ohne Einteilung,
350 x 125 mm



860.0858
Ablageboden ohne Einteilung,
450 x 150 mm



860.0859
Lagersichtkastenhalter einfach, für
Größe 7 und 8



860.0870
Universal-Werkzeugaufnahme,
390 x 45mm



860.0871
Universal-Werkzeugaufnahmebox,
55 x 310 x 125mm mit Holzplatte
zum Selbstbohren

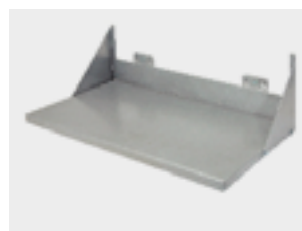

860.0878
Stahlblechablage, 435 x 250 mm



860.0873
Stecknusshalter, 9 Löcher,
390 x 30mm



860.0879
Papierrollenhalter, 355 mm



860.0880
Prospekthalter, 220 x 310 mm



860.0881 Zeichnungshalter,
220 x 310 mm



860.0886
Werkzeughalter für MK-2 und MK-3,
16 Löcher



860.0882 Magnet-Set, Ø 25 mm, rot, 10er Pack verschiedene Farben, ideal einsetzbar für Metall Oberflächen, Magnet kunststoffummantelt



860.0883 Magnet-Set, Ø 25 mm, grün, 10er Pack, verschiedene Farben, ideal einsetzbar für Metall Oberflächen, Magnet kunststoffummantelt



860.0884 Magnet-Set, Ø 25 mm, blau, 10er Pack, verschiedene Farben, ideal einsetzbar für Metall Oberflächen, Magnet kunststoffummantelt



860.0887
Bithalter, 7 Löcher, 150 x 35mm



860.0872
Innensechskanthalter, 11 Löcher, 145 x 70mm



860.0894
Stecknuss-Halter für 1/2" Stecknüsse, 6 Löcher



860.0895
Stecknuss-Halter für 1/2" Stecknüsse, 13 Löcher



860.0801
Werkzeughalter mit geradem Dorn Ø 6 mm, 50 mm



860.0802
Werkzeughalter mit geradem Dorn Ø 6 mm, 100 mm



860.0803
Werkzeughalter mit geradem Dorn Ø 6 mm, 150 mm



860.0820
Doppelter Werkzeughalter mit geradem Dorn Ø 6mm, 35 mm



860.0821
Doppelter Werkzeughalter mit geradem Dorn Ø 6 mm, 50 mm



860.0822
Doppelter Werkzeughalter mit geradem Dorn Ø 6 mm, 75 mm



860.0804
Werkzeughalter mit schrägem Hakenende Ø 6 mm, 50 mm



860.0805
Werkzeughalter mit schrägem Hakenende Ø 6 mm, 100 mm



860.0806
Werkzeughalter mit schrägem Hakenende Ø 6 mm, 150 mm



860.0807
Werkzeughalter mit schrägem Hakenende Ø 6 mm, 200 mm



860.0812
Doppelter Werkzeughalter mit schrägem Hakenende, Ø 6 mm, 35 mm



860.0813
Doppelter Werkzeughalter mit schrägem Hakenende, Ø 6 mm, 50 mm



860.0814
Doppelter Werkzeughalter mit schrägem Hakenende, Ø 6 mm, 75 mm



860.0815
Doppelter Werkzeughalter mit schrägem Hakenende, Ø 6 mm, 150 mm



860.0809
Werkzeughalter mit senkrechtem Hakenende Ø 6 mm, 35 mm



860.0810
Werkzeughalter mit senkrechtem Hakenende Ø 6 mm, 75 mm

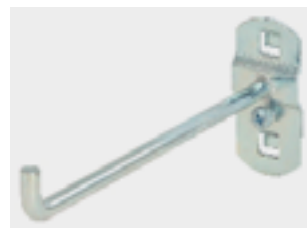

860.0811
Werkzeughalter mit senkrechtem Hakenende Ø 6 mm, 125 mm

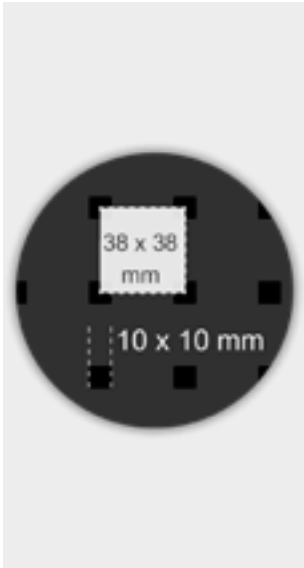

860.0816
Doppelter Werkzeughalter mit
senkrechtem Hakenende, Ø 6 mm,
35 mm



860.0817
Doppelter Werkzeughalter mit
senkrechtem Hakenende, Ø 6 mm,
50 mm

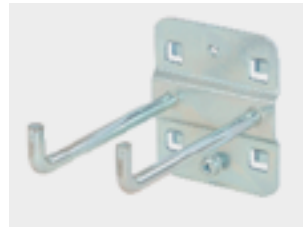

860.0818
Doppelter Werkzeughalter mit
senkrechtem Hakenende, Ø 6 mm,
75 mm



860.0819
Doppelter Werkzeughalter mit
senkrechtem Hakenende, Ø 6 mm,
150 mm



860.0824
Werkzeugklemme einfach-klein,
Ø 6 mm



860.0825
Werkzeugklemme einfach-klein,
Ø 10 mm



860.0826
Werkzeugklemme einfach-klein,
Ø 13 mm



860.0827
Werkzeugklemme einfach-klein,
Ø 16 mm



860.0828
Werkzeugklemme einfach-klein,
Ø 19 mm



860.0829
Werkzeugklemme doppelt-klein,
Ø 6 mm



860.0830
Werkzeugklemme doppelt-klein,
Ø 10 mm



860.0831
Werkzeugklemme doppelt-klein,
Ø 13 mm



860.0832
Werkzeugklemme doppelt-klein,
Ø 16 mm



860.0833
Werkzeugklemme doppelt-klein,
Ø 19 mm



860.0834
Werkzeugklemme einfach-groß,
25 mm



860.0835
Werkzeugklemme einfach-groß,
28 mm

ZUBEHÖR



860.0836
Werkzeugklemme einfach-groß,
32 mm

2,90
EUR



860.0823
Schräghaken für Nüsse und Steck-
schlüssel Ø 6 mm

1,90
EUR



860.0837
Zangenhalter-Tiefe 20mm, 35 mm

2,50
EUR



860.0838
Zangenhalter-Tiefe 20mm, 55 mm

2,50
EUR



860.0839
Zangenhalter-Tiefe 20mm, 75 mm

3,50
EUR



860.0840
Rundhalter, 25 x 65 mm

2,90
EUR



860.0841
Maschinenhalter, Ø 40 mm

2,90
EUR



860.0842
Maschinenhalter, Ø 60 mm

3,50
EUR



860.0843
Maschinenhalter, Ø 80 mm

3,90
EUR



860.0844
Werkzeughalter-3-fach, Ø 6 mm,
150 mm

3,50
EUR



860.0874
Kabelhalter, 150 mm

4,90
EUR



860.0875
Kabelhalter, 200 mm

4,90
EUR



860.0876
Werkzeughalter für
SB-Verpackungen, 125 mm

3,50
EUR



860.0877
Werkzeughalter für
SB-Verpackungen, 150 mm

3,90
EUR

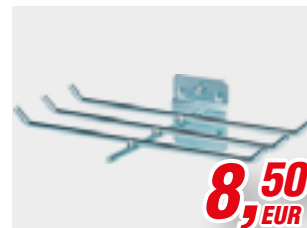

860.0845
Sechsfach Werkzeughalter-
Hakenenden, 45° abgewinkelt

8,50
EUR



860.0860
Grundplatten, klein

1,90
EUR



860.0861
Grundplatten, groß

2,50
EUR



860.0862
Lagersichtskastenhalter,
550 x 40mm

14,90
EUR



17,90
EUR

860.0863
Lagersichtskastenhalter,
550 x 60mm



12,90
EUR

860.0864
Schraubenschlüsselhalter für 10
Schlüssel, 145 mm



17,90
EUR

860.0865
Schraubenschlüsselhalter für 10
Schlüssel, 225 mm



9,50
EUR

860.0866
Runddosenhalter Ø 70 mm, 100 mm

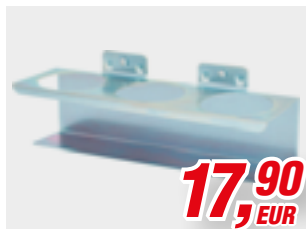

17,90
EUR

860.0867
Runddosenhalter Ø 70 mm, 300 mm



14,90
EUR

860.0868
Schlauchhalter, 230 x 70mm

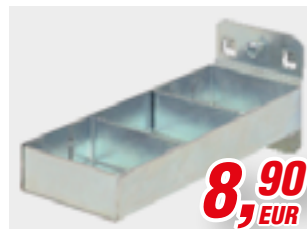

8,90
EUR

860.0847
Kleinteileablage mit Einteilung,
150 x 55 mm



8,90
EUR

860.0848
Kleinteileablage ohne Einteilung,
150 x 55 mm



12,90
EUR

860.0869
Universal-Werkzeugaufnahme,
120 x 70mm mit Kunststoffklotz zum
Selbstbohren



3,90
EUR

860.0846
Kombinationshalter, 150 x 55 mm



8,90
EUR

860.0849
Schraubenschlüsselhalter-waage-
recht, 8 Löcher

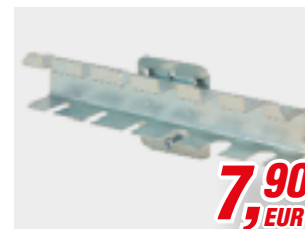

7,90
EUR

860.0850
Schraubendreherhalter, 6 Löcher,
150 x 55mm



14,90
EUR

860.0851
Schraubendreherhalter, 12 Löcher,
150 x 55mm



9,50
EUR

860.0852
Bohrer- und Innensechskanthalter,
14 Löcher



19,90
EUR

860.0853
Bohrer- und Innensechskanthalter,
28 Löcher



4,50
EUR

860.0854
Sägenhalter, 4 Löcher, 150 mm
paarweise zu benutzen

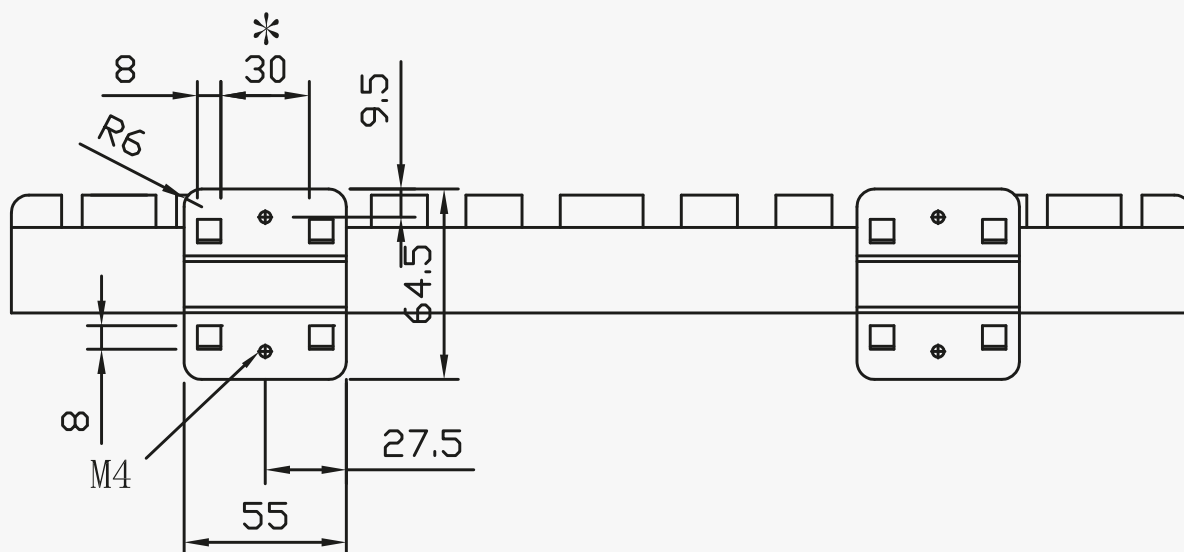

BRINGEN SIE IHREN SCHATZ UNTER DIE HAUBE

Wer mit Performance Plus arbeitet, der möchte vermutlich nicht so schnell Feierabend machen. Wenn es dann aber doch so weit ist, können Sie Ihren Werkstattwagen mit der passenden Haube vor Staub und Kratzern schützen.



P40



873.0040
Abdeckhaube zu Werkstattwagen
P40, 1740x750x860 mm